

TECSYSTEM S.r.l.®

# INSTRUCTION MANUAL

**T-154**  
**0-240°C**

**TECSYSTEM S.r.l.**  
Via Cristoforo Colombo, 5  
20094 Corsico (MI) Italy  
Tel. +39 - 02 - 4581861  
Fax: +39 - 02 - 48600783

---

<http://www.tecsystem.it>

---

R.1 15/01/02

**T-154 0-240°C protection relays**

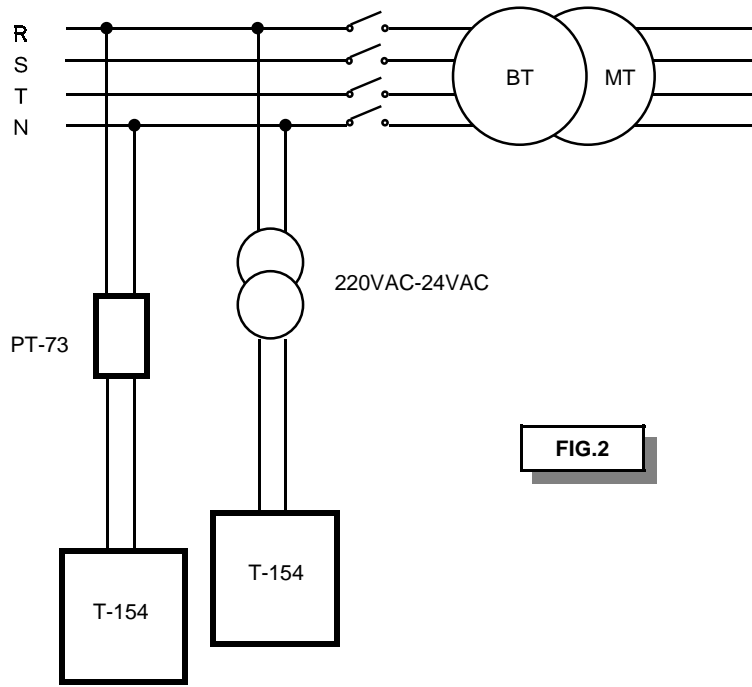

FIG.2

possible configuration of ALARM and FAULT relays parallel connection

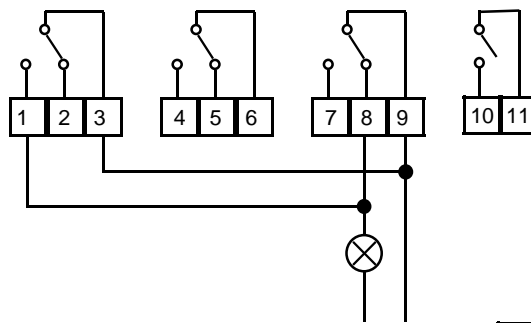

Fig.3

**1) TECHNICAL SPECIFICATIONS**

|                                                                                                                                                                                                                                                                                                                                                                                                                                                                                                                                                                                                                                                                                                                                                                                                                                                                                              |                                                                                                                                                                                                                                                                                                                                                                                                                                                                                                                                                                                                                                                                                                                                                                                                                                                                 |
|----------------------------------------------------------------------------------------------------------------------------------------------------------------------------------------------------------------------------------------------------------------------------------------------------------------------------------------------------------------------------------------------------------------------------------------------------------------------------------------------------------------------------------------------------------------------------------------------------------------------------------------------------------------------------------------------------------------------------------------------------------------------------------------------------------------------------------------------------------------------------------------------|-----------------------------------------------------------------------------------------------------------------------------------------------------------------------------------------------------------------------------------------------------------------------------------------------------------------------------------------------------------------------------------------------------------------------------------------------------------------------------------------------------------------------------------------------------------------------------------------------------------------------------------------------------------------------------------------------------------------------------------------------------------------------------------------------------------------------------------------------------------------|
| <p><b>AUXILIARY POWER SUPPLY</b></p> <ul style="list-style-type: none"> <li>• Rated voltage 24-240 Vac-dc</li> <li>• Maximum ratings 20-270 Vac-dc</li> </ul>                                                                                                                                                                                                                                                                                                                                                                                                                                                                                                                                                                                                                                                                                                                                |                                                                                                                                                                                                                                                                                                                                                                                                                                                                                                                                                                                                                                                                                                                                                                                                                                                                 |
| <p><b>INPUTS</b></p> <ul style="list-style-type: none"> <li>• 3 or 4 inputs RTD Pt100 sensors-3 wires</li> <li>• removable rear terminals</li> <li>• input channels protected against electromagnetic noises and spikes</li> <li>• sensors length cables compensation up</li> </ul>                                                                                                                                                                                                                                                                                                                                                                                                                                                                                                                                                                                                          | <p><b>OUTPUTS</b></p> <ul style="list-style-type: none"> <li>• 2 alarm relays (ALARM-TRIP)</li> <li>• 1 alarm relay for fan control (FAN)</li> <li>• 1 alarm relay for sensor fault or working anomaly (FAULT)</li> <li>• output contacts capacity: 5A-250 Vac res.</li> </ul>                                                                                                                                                                                                                                                                                                                                                                                                                                                                                                                                                                                  |
| <p><b>TEST AND PERFORMANCES</b></p> <ul style="list-style-type: none"> <li>• Assembling in accordance with CE rules</li> <li>• Protection against electrical and magnetic noises: CEI-EN50081-2/50082-2</li> <li>• Dielectric strength: 2500 Vac for 1 min. from relays to sensors, relays to power supply, power supply to sensors</li> <li>• Accuracy: <math>\pm 1\%</math> full scale, <math>\pm 1</math> digit</li> <li>• Ambient operating temperature: -20°C to 60°C</li> <li>• Humidity: 90% non-condensing</li> <li>• ABS self-extinguishing housing-NORYL 94VO</li> <li>• <b>Opt.</b> Frontal plastic protection</li> <li>• <b>Opt.</b> Protection treatment of electronic part</li> <li>• Frontal polycarbonate-IP65</li> <li>• Burden: 3VA</li> <li>• Data storage: 10 years minimum</li> <li>• Digital linearity of sensors signal</li> <li>• Self-diagnostic circuit</li> </ul> | <p><b>DISPLAYING AND DATA MANAGEMENT</b></p> <ul style="list-style-type: none"> <li>• 1 display 13 mm high with 3 digits for displaying temperatures</li> <li>• LED for displaying reference channel</li> <li>• LED indicating alarm or trip channel</li> <li>• LED indicating fault</li> <li>• Temperature monitoring from 0-240°C</li> <li>• 2 alarm thresholds</li> <li>• 2 alarm ON-OFF thresholds for fan control</li> <li>• Sensors diagnostic (Fcc-Foc-Fcd)</li> <li>• Entering the programming by frontal push button</li> <li>• Automatic output from programming cycle after 1 minute of no operation</li> <li>• wrong programming automatic display</li> <li>• Programmed data call out</li> <li>• Possibility of setting automatic channel scanning, hottest channel, manual scanning</li> <li>• Maximum temperatures and alarms storage</li> </ul> |
| <p><b>DIMENSIONS</b></p> <ul style="list-style-type: none"> <li>• 96x96 mm-DIN43700 – depth 140mm (with rear terminals)</li> <li>• panel cutout 92x92 mm</li> </ul>                                                                                                                                                                                                                                                                                                                                                                                                                                                                                                                                                                                                                                                                                                                          |                                                                                                                                                                                                                                                                                                                                                                                                                                                                                                                                                                                                                                                                                                                                                                                                                                                                 |

**2) MOUNTING**

Make a hole with the dimensions of 92x92 mm in the panel plate.  
Fasten firmly the unit by the fixing blocks included with each unit.

**3) POWER SUPPLY**

The T-154 unit has a universal power supply. It can be supplied with 24 to 240 Vac or dc without respect to polarities.

The ground cable must be fixed to terminal # 41.

ATTENTION: the unit may be damaged by overvoltage when power is supplied directly from the secondary of the transformer it is monitoring. This may occur when the 220V is obtained directly from the secondary winding and there are fixed capacitors online.

**4) ALARMS AND FAN CONTROL ELECTRICAL CONNECTIONS**

Take the removable terminal board off the unit before wiring.

*In order to protect the electronic apparatus, we suggest the application of the electronic dischargers of the series PT-73 mono or double phase.  
Alternatively, we suggest the application of a 24 Vac or better 24 Vdc power supply.*

ALARM and TRIP relays energize only when the prefixed temperature limits are reached (NO Fail Safe) or reset when the prefixed temperature limits are reached (Fail Safe).

The FAULT relay always energizes when the apparatus is powered and it resets when the Pt100's are damaged or when there is no power voltage.

The FAN relay can be used for fan control or else it can be included in the conditioning circuit of the transformer box.

**5) THERMOMETRIC SENSORS CONNECTION**

Each Pt100 sensor has three conductors : one white and two red (CEI 75.8)

Fig.1 shows the disposition in the terminal board of the connection cables to the unit.

Channel 2 must be always referred to the central column of the transformer.

Channel 4 must be always referred to the core of the transformer or else to the ambient Pt100 sensor, if you want to monitor the temperature of the transformer box through the T-154 unit.

**6) MEASURE SIGNALS TRANSPORT**

All transport cables of the Pt100 measure signals must absolutely:

- be divided from the power ones
- be realized with shielded cable with twisted conductors
- have a section of min 0.5 mm<sup>2</sup>
- be twisted if you have no shield
- be firmly fixed in the terminal board
- have tinned or silvered conductors

All units of the "T" series have the sensors linearization with a max error of 1% v.f.s..

*TECSYSTEM has realised a special cable for the measure signal transport with all the protection requirements in accordance with CEI Norms: **mod. CT-ES***

**7) THERMOMETRIC SENSORS DIAGNOSTIC**

In the event one of the thermometric sensors installed on the machine to protect is damaged, the **FAULT** relay energizes immediately, the **ALARM** and **TRIP** LED of the damaged channel (Chn) lighten and the **FAULT LED** is lightening.

The screen will automatically display a message showing the fault condition:

- **Fcc** sensor is short circuited
- **Foc** sensor is open

During the unit normal operation, if the **Fcd/YES** function has been selected the display will show **Fcd** indicating that a sensor is damaged and the LED corresponding to the affected channel will lighten (Chn).

The **FAULT** relay energizes giving a signal to the operator.

After the replacement of the damaged sensor, you can **RESET** the alarm pushing **RESET** until the display shows the message **RST**.

**8) TEMPERATURES DIAGNOSTIC**

When one of the thermometric sensors surveys a temperature exceeding by 1°C the alarm limit, after 4 seconds the **ALARM** relay will energize and the **ALARM** LED of the affected channel (Chn) will switch on.

The same occurs when the **TRIP** temperature limit is detected: the **TRIP** relay energizes and the **TRIP** LED corresponding to the affected channel is lightening.

When the surveyed temperature declines of 1°C below the prefixed limit for the **ALARM** and **TRIP** switching, the relays de-energize and the respective LED's switch off.

**9) COOLING-FAN CONTROL**

The T-154 unit, if suitably programmed, can control the ON-OFF of the transformer fans according to the set temperature values.

The fans of the machine can be controlled in two different ways:

- using the temperatures surveyed by the sensors on the three columns  
**Channel 1.2.3**  
ALARM and TRIP LED CH 1.2.3 illuminated  
(e.g. ON at 80°C - OFF at 70°C)
- by an additional sensor (**CH4/YES**) for the ambient temperature inside the transformer box.  
**Channel 4**  
ALARM e TRIP LED Ch4 illuminated  
(e.g. ON at 40°C - OFF at 30°C)

Press UP or DOWN key to select this function.

**10) FAN TEST**

By programming (**hxx**) you can establish to have the fans set for 5 minutes every "xx" hours, independently on columns or ambient temperature values.

This function has the purpose to verify periodically the fans working, when they are not in use.

By setting **h00** this functions is disabled.

**11) DISPLAY MODE**

By pressing DISPLAY MODE you can select one of the three display modes:

- *AUTO*: the display shows automatically the temperature of the hottest channel
- *MAN*: each channel may be viewed manually by pressing the UP or DOWN key
- *T.MAX*: the unit shows the max. temperature recorded by the sensors and any alarms recorded after the last reset.

**12) WORKING PROGRAM CONTROL**

To review the entered values momentarily press PRG key and continue to do so advancing to each programmed value. Press ENT to return to normal operating mode.

**13) LAMP TEST**

It is advisable to carry out this test on a regular basis to ensure all lamps are functioning normally. Pressing the TEST key at any time allows the user to test all lamps

*If any lamp is not functioning the unit must be returned for repair.*

**14) ALARM RELAYS TEST**

All relays may be tested using the following procedure.  
Press and hold the TEST key for 5 seconds. Initially all LED's illuminate, changing to the main screen display flashing TST.

Release the test key when the yellow relay test LED illuminates.

The screen display will show the relay selected for testing and the respective LED will be illuminated.

The relays to test will be indicated on the display by:

- "Fan" :cooling relay
- "Fit" :Pt100 fault relay
- "Alr" :alarm relay
- "trP" :trip relay

Use the Scroll UP or DOWN keys to make the selection. Press the SET key to perform the test on the selected relay. To reset press the RESET key.

To discontinue operation and revert to normal operation, press the TEST key.

At the start of the test, a timer is automatically initiated which reverts the unit to normal operation if no inputs are detected for a period of five minutes.

**15) ALARM RELAY EXCLUSION**











The alarm relay will change contact state when the alarm set point temperature value is reached. An illuminated alarm LED provides indication of the affected channel. To reset the relay contact, press the RESET key. The alarm LED corresponding to the affected channel will start flashing to indicate that an alarm temperature value has been reached. If the set point alarm value is exceeded up to a value of 5 °C below the set trip threshold, the alarm relay will change contact state again and the alarm LED will illuminate. Once again press the RESET key to reset the relay contact. When the trip set point temperature value is reached, the trip relay will change contact state and both the yellow alarm and the red trip LED's illuminate.

**16) IMPORTANT NOTICE**

**Before conducting the insulation test, disconnect the power supply to the unit to avoid damage.**

**TECSYSTEM S.r.l ®**

**17) PROGRAMMING**

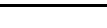
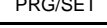
| N° | KEY                                                                                 | DISPLAY                                                                                                                                        | NOTES                                                                                 |
|----|-------------------------------------------------------------------------------------|------------------------------------------------------------------------------------------------------------------------------------------------|---------------------------------------------------------------------------------------|
| 1  | PRG/SET                                                                             | To begin programming press and hold PRG/SET. PRG will flash for 7 sec. When PRG stops flashing, default alarm setpoint will appear on display. | Program LED will light                                                                |
| 2  |    | Enter the desired Limit setpoint for Ch 1-2-3                                                                                                  |                                                                                       |
| 3  | PRG/SET                                                                             | TRIP set T° appears                                                                                                                            |                                                                                       |
| 4  |    | Enter the desired Trip setpoint for Ch 1-2-3                                                                                                   |                                                                                       |
| 5  | PRG/SET                                                                             | <b>CH4</b> appears on the display                                                                                                              |                                                                                       |
| 6  |    | Enter <b>CH4 YES</b> or <b>NO</b>                                                                                                              | <b>YES:</b> Ch4 enabled<br><b>NO:</b> CH4 disabled                                    |
| 7  | PRG/SET                                                                             | ALARM set T° appears                                                                                                                           | only if <b>YES</b> was chosen at step 6.                                              |
| 8  |    | Enter the desired Trip setpoint for Ch 4                                                                                                       |                                                                                       |
| 9  | PRG/SET                                                                             | TRIP set T° appears                                                                                                                            | only if <b>YES</b> was chosen at step 6.                                              |
| 10 |    | Enter the desired Trip setpoint for Ch 4                                                                                                       |                                                                                       |
| 11 | PRG/SET                                                                             | "FAN" appears on display                                                                                                                       |                                                                                       |
| 12 |  | Enter FAN <b>YES</b> or <b>NO</b>                                                                                                              | <b>YES:</b> FAN contacts enabled<br><b>NO:</b> FAN contacts disabled                  |
| 13 | PRG/SET                                                                             | Status of FAN control will appear on the display as <b>CHF</b>                                                                                 | only if <b>YES</b> was chosen at steps 6 and 12.                                      |
| 14 |  | set up CH 1,2,3, or CH4                                                                                                                        | respective LED alight                                                                 |
| 15 | PRG/SET                                                                             | <b>ON</b> appears on display                                                                                                                   |                                                                                       |
| 16 | PRG/SET                                                                             | The <b>ON</b> T° appears                                                                                                                       |                                                                                       |
| 17 |  | Enter desired setpoint for fan to turn off                                                                                                     | only if <b>YES</b> was chosen at step 12.                                             |
| 18 | PRG/SET                                                                             | <b>OFF</b> appears on display                                                                                                                  |                                                                                       |
| 19 | PRG/SET                                                                             | The <b>OFF</b> T° appears                                                                                                                      |                                                                                       |
| 20 |  | Enter the desired temperature for fan to turn on                                                                                               | only if <b>YES</b> was chosen at step 12.                                             |
| 21 | PRG/SET                                                                             | Status of FAN control TEST will appear on the display as <b>h00</b>                                                                            |                                                                                       |
| 22 |  | set up the number of hours                                                                                                                     | only if at step 12 you chose <b>YES</b><br><b>h00</b> = function disabled             |
| 23 | PRG/SET                                                                             | <b>Fcd</b> appears on display                                                                                                                  |                                                                                       |
| 24 |  | Enter <b>Fcd YES</b> or <b>NO</b>                                                                                                              | <b>Fcd YES</b> = unit will indicate damaged sensor.<br><b>Fcd NO</b> = indicator off. |
| 25 | PRG/SET                                                                             | <b>PRG</b> appears on display                                                                                                                  |                                                                                       |
| 26 |  | set up <b>Prg YES</b> or <b>no</b>                                                                                                             | <b>Prg NO</b> = program cannot be changed                                             |
| 27 | ENT                                                                                 | Programming is completed.                                                                                                                      | The unit will perform the light test.                                                 |
| 28 | PRG/SET                                                                             | Press ENT to return to normal operating mode.                                                                                                  |                                                                                       |



**18) PROGRAMMING REHABILITATION IN CASE OF BLOCK (Prg no)**

In the event program access is blocked the display will show SET and then display "noP". To gain access, press the ENT key and return to normal operation. Touch the PRG key and then, press and hold the TEST key for approximately 7 seconds until the flashing PRG screen display ends, and the message nCH is displayed.

NOTE: this procedure removes the lockout feature. To block access again, this feature must be reprogrammed.

**19) WARRANTY**

The "T" series units are warranted for a period of 12 months from the delivery date marked on the unit.

Warranty is limited to repair or replacement of the defective products and no contingent liabilities will be accepted.

Warranty will be voided if the unit is found to be tampered with or when it has been damaged as a result of incorrect input or power supply connections (out of the max working limits 20+270 Vac-dc). Warranty will be voided if the unit is damaged as a result of transitory overvoltages. Freight expense is not covered under warranty.

In case of dispute, the qualified FORUM is the one in Milan.

**20) PT100 EXTENSION CABLE: TECHNICAL SPECIFICATIONS**

Cable 20xAWG 20/19 cu/stg

Section 0.55 mm<sup>2</sup>

Antiflame Insulation PVC105

In accordance with CEI 20.35 IEC 332.1

Max. working temperature: 105°C

Conformation : 4 terns of the numbered conductors (1-1-1.....4-4-4)

RRW twisted and coloured conductors

Shield cu/stg

PVC Antiflame protecting covering

External diameter 9.0 mm

Skeins of 100 m

**TROUBLESHOOTING**

| PROBLEMS                                                                                                     | CAUSES / SOLUTIONS                                                                                                                                                                                                                                                                |
|--------------------------------------------------------------------------------------------------------------|-----------------------------------------------------------------------------------------------------------------------------------------------------------------------------------------------------------------------------------------------------------------------------------|
| The unit will not switch on, with control power energized                                                    | Check the terminal block for correct installation. Check for voltage at the terminal block                                                                                                                                                                                        |
| Channel 4 is indicating fault and displaying FOC (only three Pt100 sensors are connected)                    | Wrong programming of the unit.<br><i>Repeat programming.</i>                                                                                                                                                                                                                      |
| One of the 3/4 channels is indicating fault and displaying FOC/FCC                                           | Check the sensors connection.<br>Look for damaged sensors.<br><i>Replace damaged sensor</i>                                                                                                                                                                                       |
| When switching the unit on-off, the alarm and trip relays energize                                           | Strong electrical noise is being picked up on the power line.<br><i>Install a transient suppressor (PT-73.)</i><br>Check to ensure the shield of the sensor cable is connected to the panel ground.<br><i>Install shielded cable (Mod. CT-ES) or twist the sensor conductors.</i> |
| All the sensors are displaying FCC.                                                                          | Wrong wiring connections. The terminal block is upside-down.                                                                                                                                                                                                                      |
| The temperature indicated by one or more channels is wrong.                                                  | The sensors are defective.<br><i>Check the sensor resistance with an Ohmmetre.</i><br>The unit is calibrated incorrectly.<br>Return for repair.                                                                                                                                   |
| With a control power source of 24 VDC the unit switches off and will not switch back on.                     | Check the input voltage is between 20-24 VDC.<br>Reconnect to a stable source of power.<br>Return if unit does not respond                                                                                                                                                        |
| Sudden activation of the trip relay with normal operating temperature.<br>One channel caused the occurrence. | Sensor defective (Fcd).<br><i>Replace the sensor.</i>                                                                                                                                                                                                                             |

**FIG.1** **T-154 ELECTRICAL CONNECTION**

Pt100 SENSORS CONNECTION

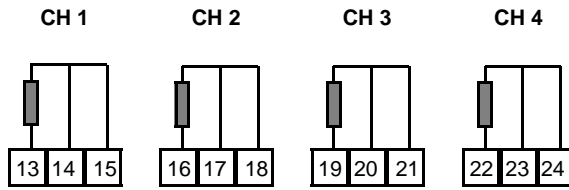

RELAYS CONNECTION

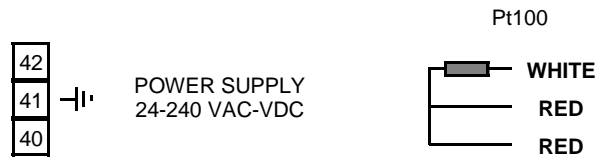
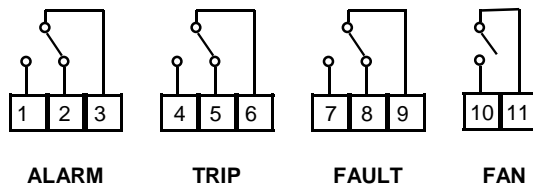

**T154 0-240°C TEST DESCRIPTION**

The unit was submitted to the following tests during production:

| N° | Description                                                     |
|----|-----------------------------------------------------------------|
| 1  | PC board test                                                   |
| 2  | Input test                                                      |
| 3  | Test of relay contacts and outputs                              |
| 4  | Key test                                                        |
| 5  | Lamp test                                                       |
| 6  | Calibration at 100 and 200°C (for temperature monitoring units) |
| 7  | Software test                                                   |
| 8  | Burn-in minimum 24h                                             |

Date of shipment: