

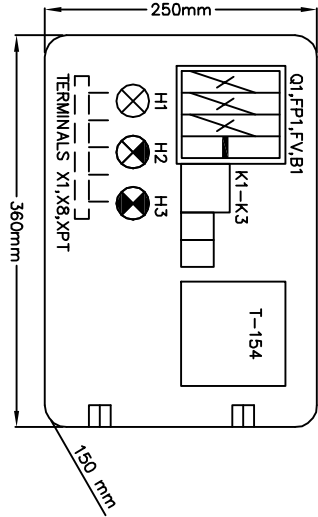

∴



INFORMATION'S  
 SWITCHBOARD:  
 FAULT CURRENT: 10KA  
 WEIGHT: 30KG  
 USE: INTERNAL  
 /EXTERNAL  
 /SPECIAL  
 LOAD FACTOR: 0,6  
 DEGREE OF PROTECTION: IP-44

QUANTITY  
 30

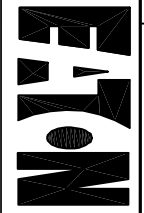

DESCRIPTION	SIGN	DESIGN	DRAWN	DATE	N <sup>o</sup>

<b>ARDAN-Electrical Engineering Ltd.</b> S.HATTOCHEN 2, CAESAREA IND.PARK 38900 Tel. 04-6327800 Fax 04-6327881 P.O.B.3066	
TRANSFORMER CONTROL CABINET /ARDAN INDUSTRIES LTD TRANSFORMER CONTROL CABINET FRONT VIEW	Drawing n. 700-03495-001 VERSION 6 TOTAL
AS MADE <input type="radio"/>	FOR CONST. <input checked="" type="radio"/>
OC	FOR APPR. <input checked="" type="radio"/>
OB	QA
0A	FILE NAME

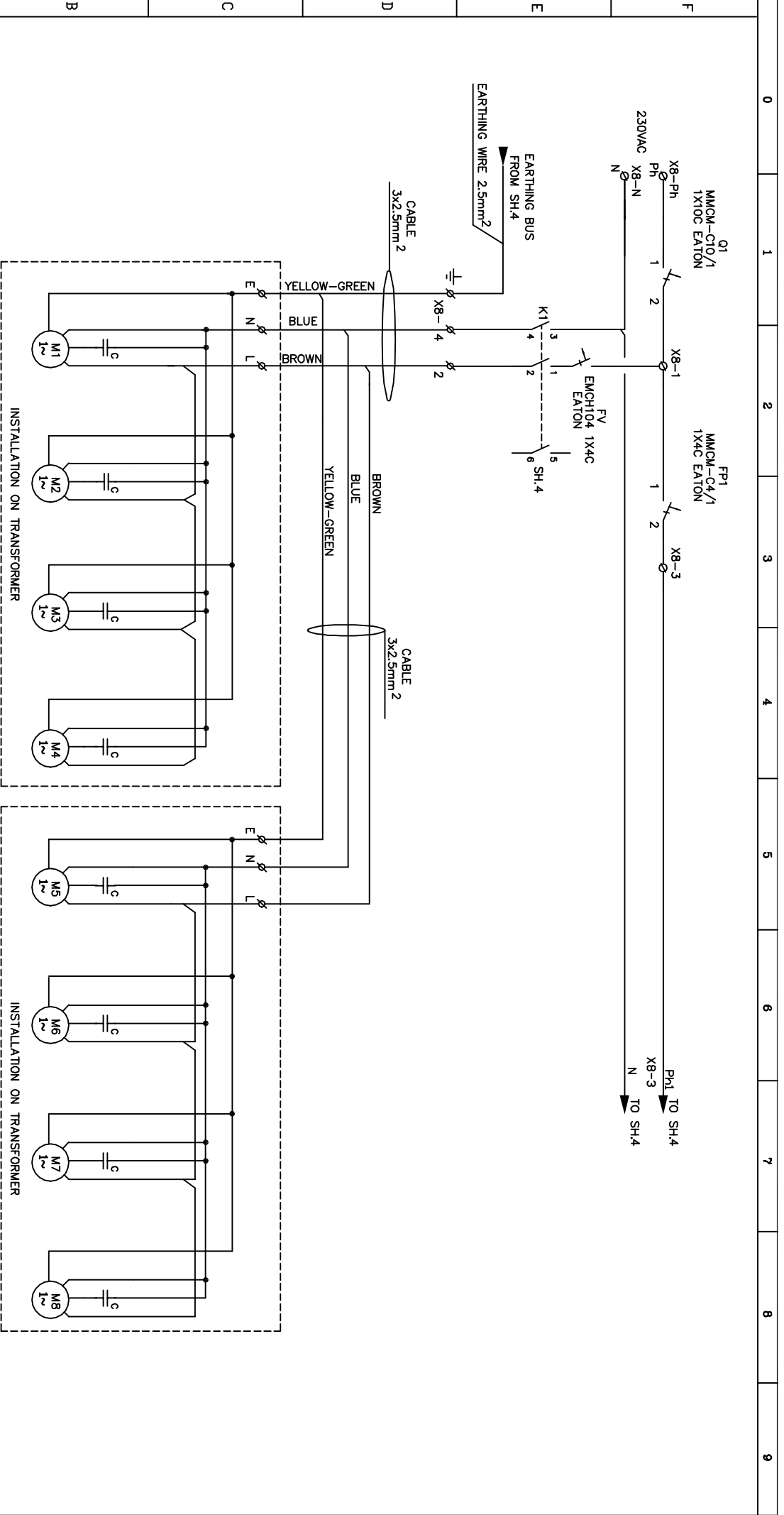

DESCRIPTION	SIGN	DESIGN	DRAWN	DATE	N <sup>o</sup>	CHANGE	SIGN	DATE	NAME	DRAW	DESIGN	CHECK
							WKA	15.02.12	WKA			
								15.02.12	GREGORY			
								15.02.12	GREGORY			

**ARDAN-Electrical Engineering Ltd.**  
 SHATTOCHEN 2, CAESAREA IND.PARK 38900 Tel. 04-6327800 Fax 04-6327881 P.O.B.3066

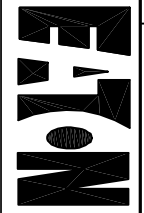

TRANSFORMER CONTROL CABINET		Drawing n.°		700-03495-001		3		Pg. Num.	
TRANSFORMER CONTROL CABINET		VERSION		1		6		TOTAL	
SINGLE LINE DIAGRAM		AS MADE		FOR CONST.		FOR APPR.		700-03495-001 FILE NAME	
		OC		OB		OA			

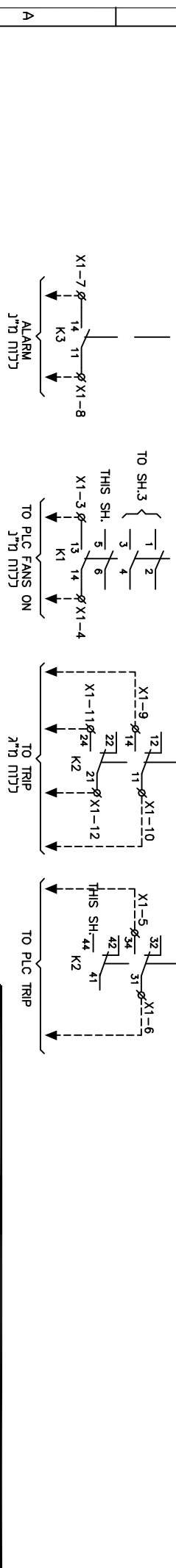
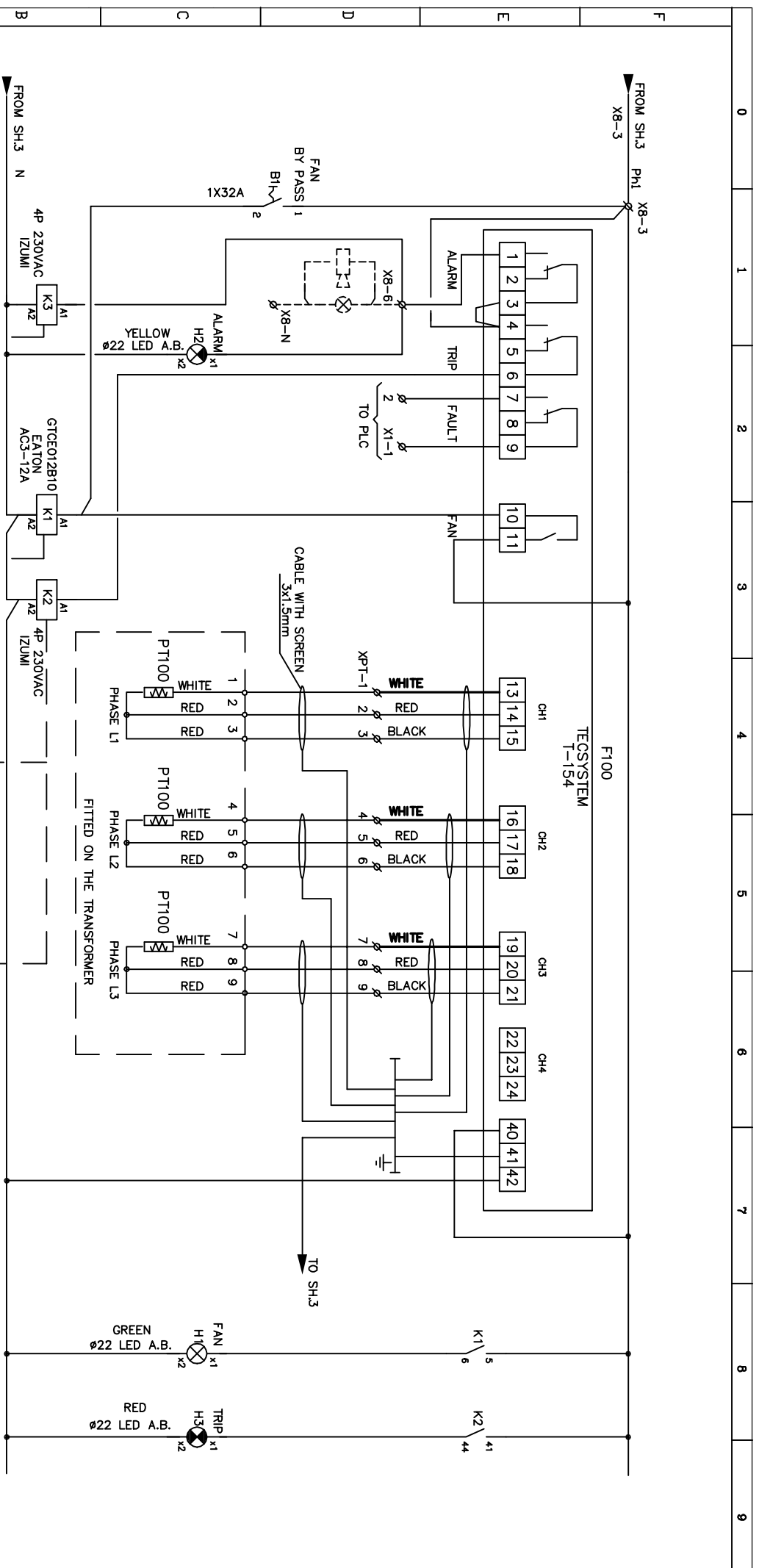

**ARDAN-Electrical Engineering Ltd.**  
 S.H.AHOCHEN 2, CAESAREA IND.PARK 38900 Tel. 04-6327800 Fax 04-6327881 P.O.B.3066

DESCRIPTION	SIGN	DESIGN	DRAWN	DATE	№	SIGN	DATE	NAME
TRANSFORMER CONTROL CABINET				15.02.12		WKA	15.02.12	VKA
TRANSFORMER CONTROL CABINET				15.02.12				
CONTROL DIAGRAM				15.02.12				

  

TRANSFORMER CONTROL CABINET	700-03495-001	4	PG. Num.
TRANSFORMER CONTROL CABINET	6		TOTAL

AS MADE	FOR CONST.	FOR APPR.	FILE NAME
<input type="checkbox"/>	<input checked="" type="checkbox"/>	<input checked="" type="checkbox"/>	
00	0B	0A	



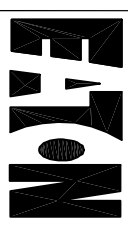

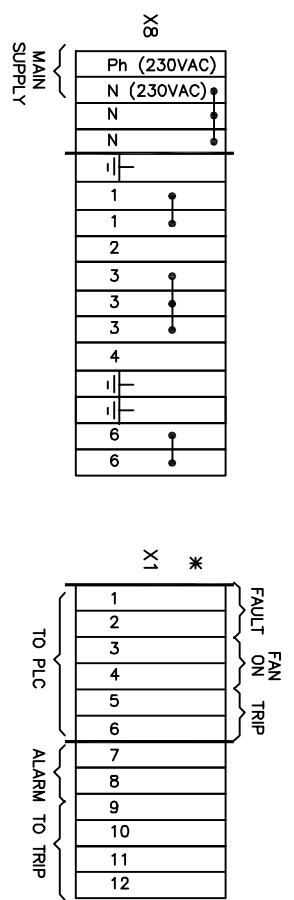
\* X1 TERMINALS 1-6 - COLOUR "ORANGE"  
 X1 TERMINALS 9-12 - COLOUR "GREY"  
 XPT TERMINALS - COLOUR "BLUE"

FOR VIEW ONLY

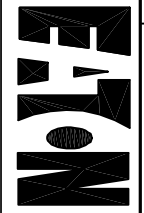

DESCRIPTION	SIGN	DESIGN	DRAWN	DATE	N <sup>o</sup>	CHANGE	SIGN	DATE	NAME	DESIGN
							WKA	15.02.12	WKA	DRAW
								15.02.12	GREGORY	DESIGN
								15.02.12	GREGORY	CHECK

**ARDAN-Electrical Engineering Ltd.**

S.HATTOCHEN 2, CAESAREA IND.PARK 38900 Tel. 04-6327800 Fax 04-6327881 P.O.B.3066

TRANSFORMER CONTROL CABINET  
 /ARDAN INDUSTRIES LTD  
 TRANSFORMER CONTROL CABINET

TERMINALS

AS MADE	FOR CONST.	FOR APPR.	700-03495-001	6	TOTAL
<input type="radio"/>	<input checked="" type="radio"/>	<input checked="" type="radio"/>			

Drawing n.°: 700-03495-001 Pg. Num.: 5